

TruPatriot Bottle Filler



We know how important your bottom line is, and how meticulously you craft your products. Which is why ABE Equipment designed the TruPatriot Bottle Filler for craft spirits and much more. The TruPatriot is the perfect option for producers looking for an easily adjustable filling line capable of producing a wide variety of bottle sizes from 350 ml – 2.25 liter. It's ideal for still beverage producers of spirits, juices, mixers, and water; as well as those producing small-batch liquid products such as hand sanitizer, olive oil, soaps, lotions and more. Fill and cork up to 10 bottles per minute based on 750 ml bottle size. Other capping solutions are available.

The TruPatriot Bottle Filler utilizes an explosion proof conveyor motor*. The electrical panel is built to UL508A standards. The unit is built using RoHS compliant materials to ensure a safe operation. It offers bottle filling specification recall and memory, and is CIP capable.

Volumetric Piston Filler

- Pneumatic operation - no electrical needed
- Fill up to 10 BPM/750 ml
- Accurate within <1% of volume
- Fill bottles ranging in size from 350 ml – 2.25 liter
- Filling compartment is easy to disassemble and clean

Corking/Capping

- Interchangeable capping options available
- Corks - silicone or natural
- 28/38 mm PCO (Plastic Closure Only)

Guardrails

- Simple adjustment
- Secures different bottle diameters

Control Box

- C1D1 Compliant
- 6" Color HMI touchscreen
- Bottle filling recall and memory

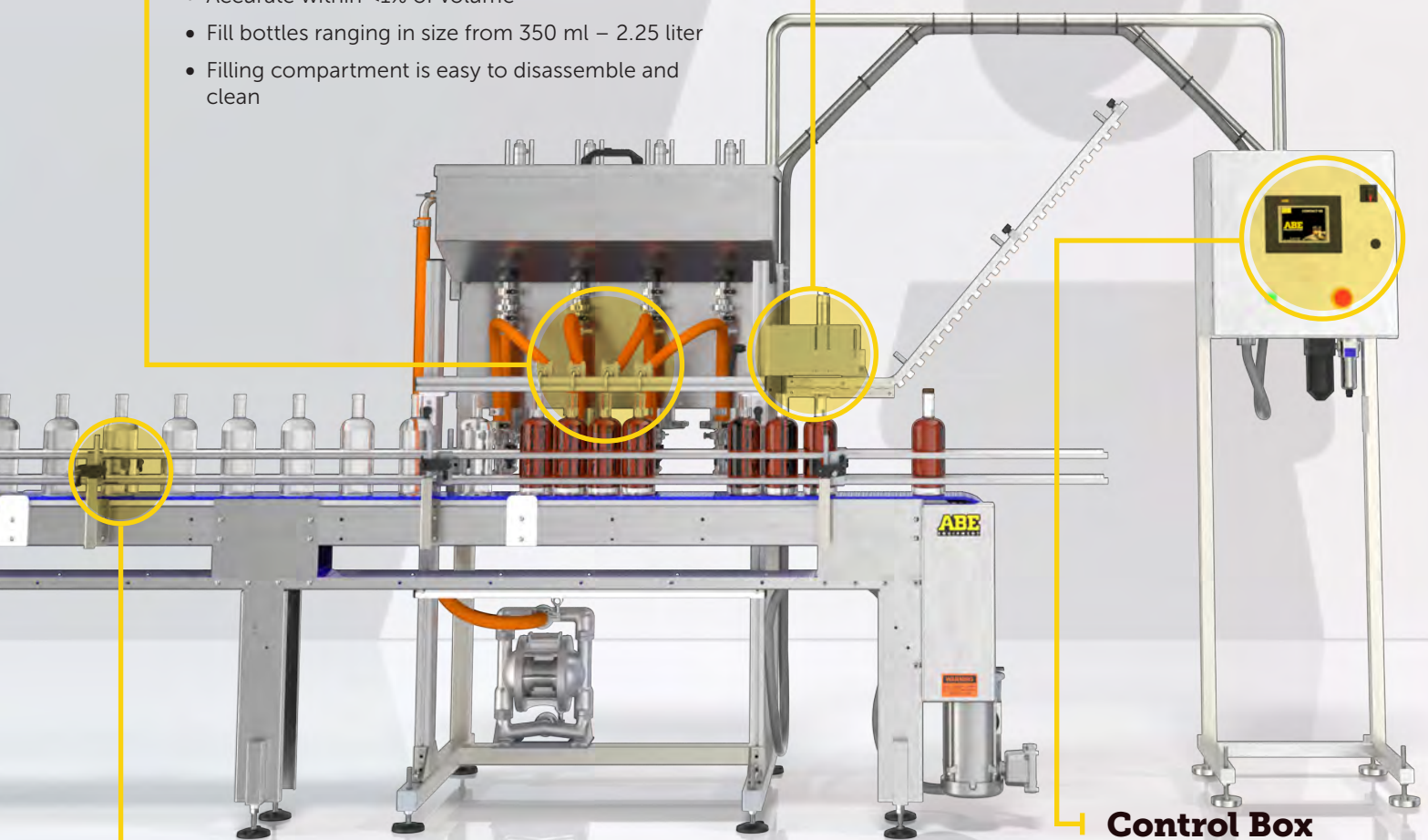

TruPatriot Bottle Filler

General Specifications

ELECTRICAL

- 208-240 V
- 60 hz
- 1 Phase
- 3 Wire

AIR & GAS

- 1/4" MQC Connection
- 8 SCFM flow rate
- 90 psi recommended

Compatible Bottles/Closures

- Fill bottles ranging in size from 350 ml – 2.25 liter
- Accepts glass, plastic, and aluminum bottles
- 28 mm to 38 mm tamper-evident cap sizes
- Works with PCO, natural and synthetic corks

Special Features

- Minimal product loss ensures maximum output
- Low maintenance applications using RoHS compliant, ethanol safe tubing, O-rings, and seals
- UL508A listed control panel
- CIP capable

Compatible Products

- Rotary Feed Table
- Inline Date Coding and Labeling
- Pack Off Table
- Batch and Mixing Tanks

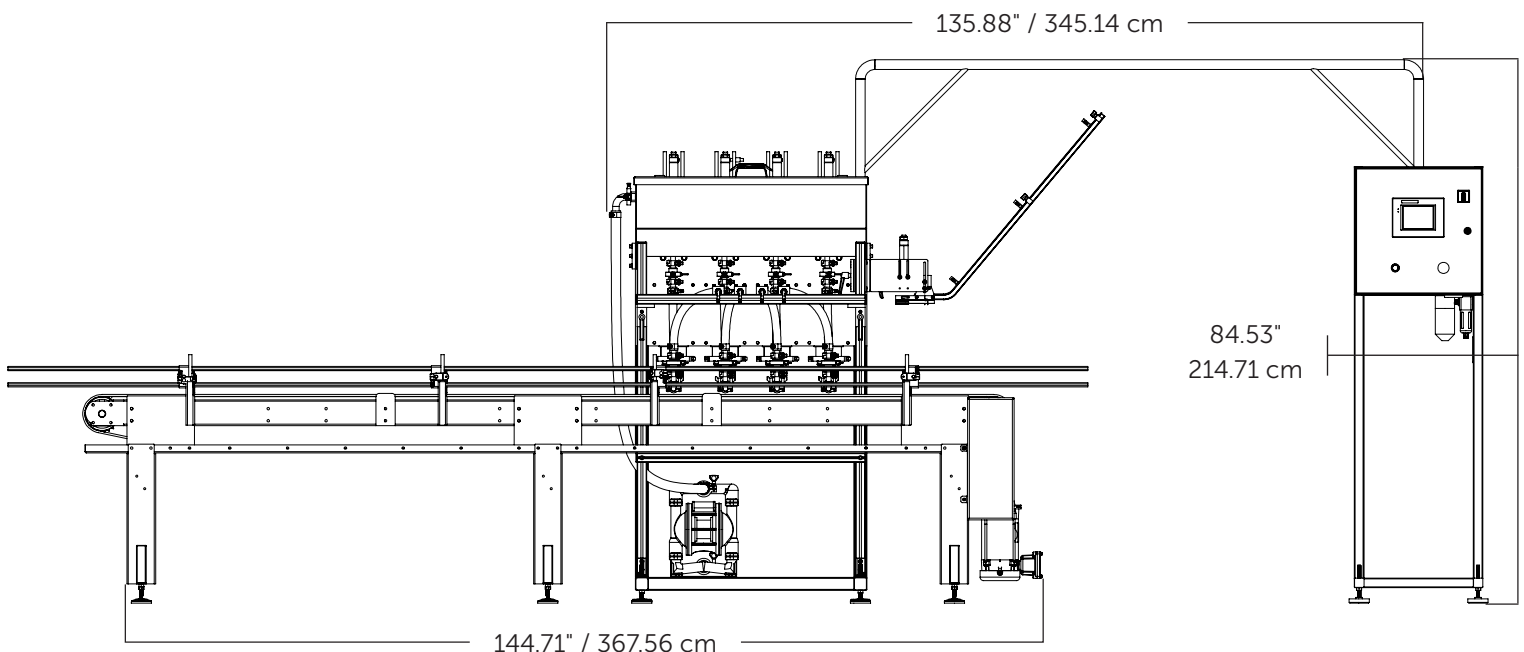

*ABE's TruPatriot is not complianced as an "explosion-proof filling system". Use equipment in a well-ventilated area to reduce flammable conditions. The operator should ensure that products to be filled do not contain elevated alcohol levels that would otherwise be volatile and/or flammable.

ABE Equipment reserves the right to change specification without notice. All specifications are approximate. ©2024 ABE Equipment