

Patriot Fill Station

ABE
EQUIPMENT

ABE is proud to introduce the one-of-a-kind Patriot Fill Station. This pneumatically operated system has an exceptionally creative bottle filling design that utilizes piston-displacement technology and offers a comprehensive range of capping options. With the freedom to apply natural or silicone corks and even tamper-evident screw caps, the Fill Station brings excellent quality and product control to a new level for small-scale packaging operations.

Filtration Station

- Wide variety of filter options available
- Easily accessible
- Stainless steel tubing

2-Head Bottle Filler

- Pneumatic operation - no electricity required
- Fill up to 8 BPM/750 ml
- Accurate within 1% of volume*
- Fill bottles ranging in size from 50 ml to 2.25 liter

Corking/Capping

- Interchangeable capping options available
- Corks - silicone or natural
- 28/38 mm PCO screw cap

Operations Cabinet

- Heavy duty stainless steel storage cabinet
- Sliding doors for clean operation
- Mobile options available



*Based on 750ml bottle

ABE
EQUIPMENT

2001 SW 6th Street | Lincoln, NE 68522 | (402) 475-2337 | ABEEquipment.com

Patriot Fill Station

General Specifications

- Pneumatic controls for safe operation; no electrical connection required
- One pneumatic connection to operate all equipment
- Semi-automatic operation
- Alternate configurations available

Your Complete Package

Each Patriot Fill Station that leaves our facility carries UL certification and an industry-leading five-year limited warranty on the metal and welds. In addition to a comprehensive spare parts inventory, you'll receive superior customer support from our team in Lincoln, Nebraska, with any ABE purchase.

Compatible Bottles/Closures

- Fill bottles ranging in size from 50 ml to 2.25 liter
- Accepts glass, plastic, and aluminum bottles
- 28 mm to 38 mm tamper-evident cap sizes
- Works with natural and synthetic corks

Compatible Products

- Tabletop Labeler
- Ozone System
- Food Grade Storage Tank
- Date and Batch Coding Options

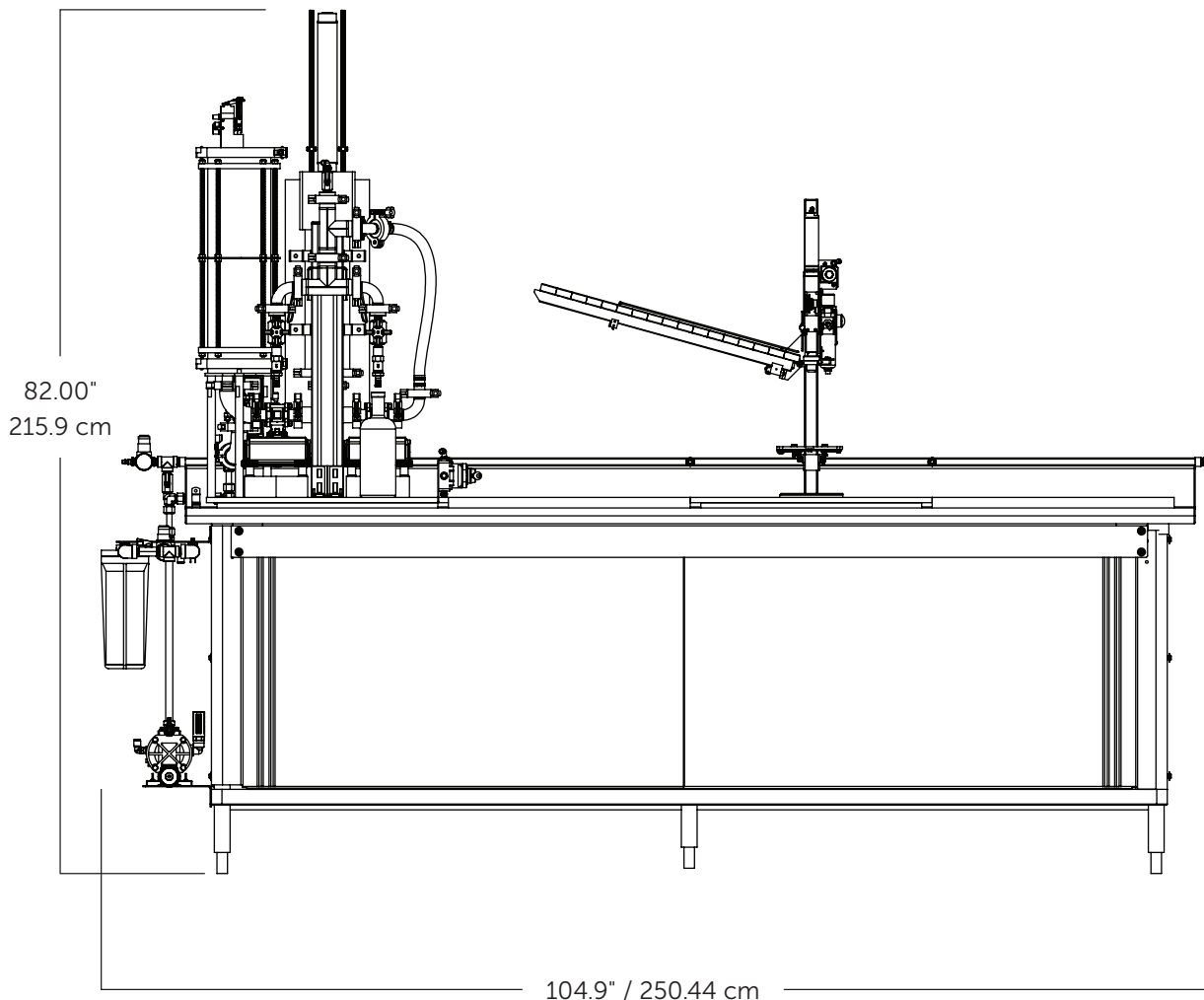

ABE Equipment reserves the right to change specification without notice. All specifications are approximate. ©2024 ABE Equipment